

Certified Re-Engineered System Bulletin:

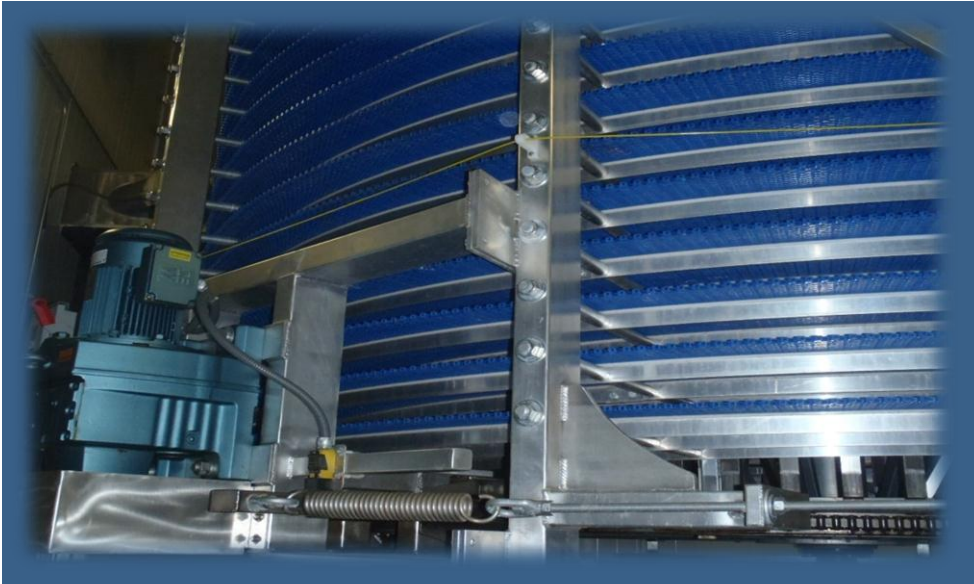

Ultra Series System in Operation - 2012

Description: Blast Freezing System
Model Number: 1-34/32-AL-200-C.W. IJW 04516
Application(s): Freezing
Condition: Excellent
Belt Width: 34" (863.6mm) (Expandable)
Direction: Ascending/Descending
Overall Height: 10'5 1/2" (3.15M)
Frame Material: Aluminum
Belt Material: Ultra Series Acetyl
Belt Type: Ultra Series
Belt Length: 865' (263.65M)
Levels: 14.25
System Diameter: 18' (5.49M)

"Every IJ White Certified Re-Engineered System offers a full OEM Warranty."

Our 5-Star Certification Process

starts with rigorous guidelines. Every system has to go through a comprehensive certification process and not all systems qualify.

Our System Inspection Team takes on an exhaustive personal overview of the process. From Main Drive Components, Reducers and Motors, to Pulleys and Wear strips, the system is reworked with a full IJW Manufacturer Warranty.

5 Star Certification Features:

- ◆ Full Manufacturer's Warranty.
- ◆ Configuration Upgrades: Down-Go, Up-Go, CW/CCW
- ◆ New Wear Components: pulleys, sprockets, rollers, wear strips and bearings.
- ◆ Sanitized and cleaned.
- ◆ Belt Inspection and Approval.

How to get started:

1. Complete an IJ White Product Specification Sheet.
2. Schedule an appointment to meet our Sales Engineering Team.
3. Review of Specifications, Customization and Project Viability.
4. Finalize and receive a System Proposal.
5. Review proposal and ensure all major deliverables have met project expectations.



Infeed to Freezer

Freezer Enclosure

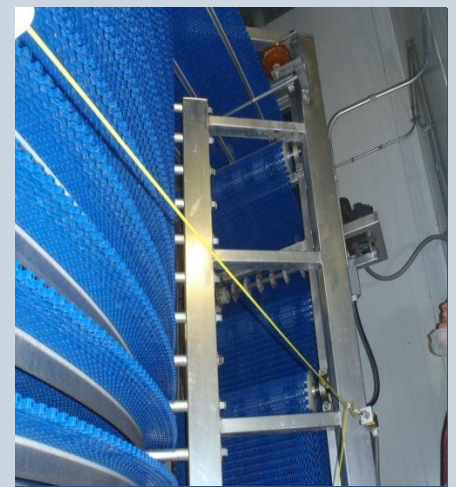

Take Up



Certified Re-Engineered System Bulletin:

Customized Configurations Available

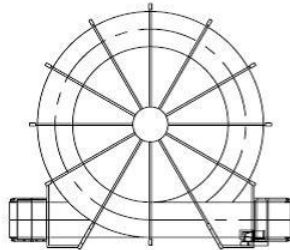

**STRAIGHT
THROUGH**

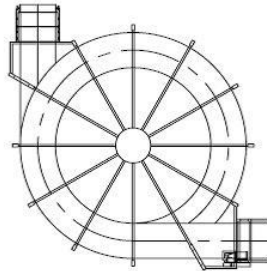

**'L' SHAPED /
90°**

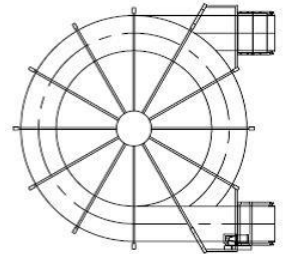

**'U' SHAPED /
180°**

More System Photos for Review:



For More Information about IJW Re-Engineered systems please call our Technical Services Team at 631-293-2211 or email us at service@ijwhite.com

I.J. WHITE ULTRA SERIES VERTICAL PROCESSING SYSTEMS (VPS) PROOFING / COOLING / FREEZING

DATE	SYM	REVISION RECORD	AUTH	DR	CHK

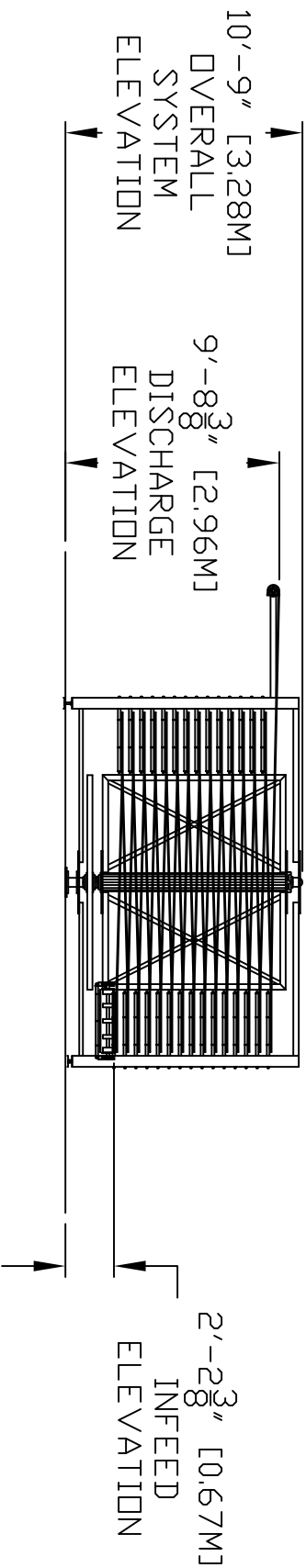
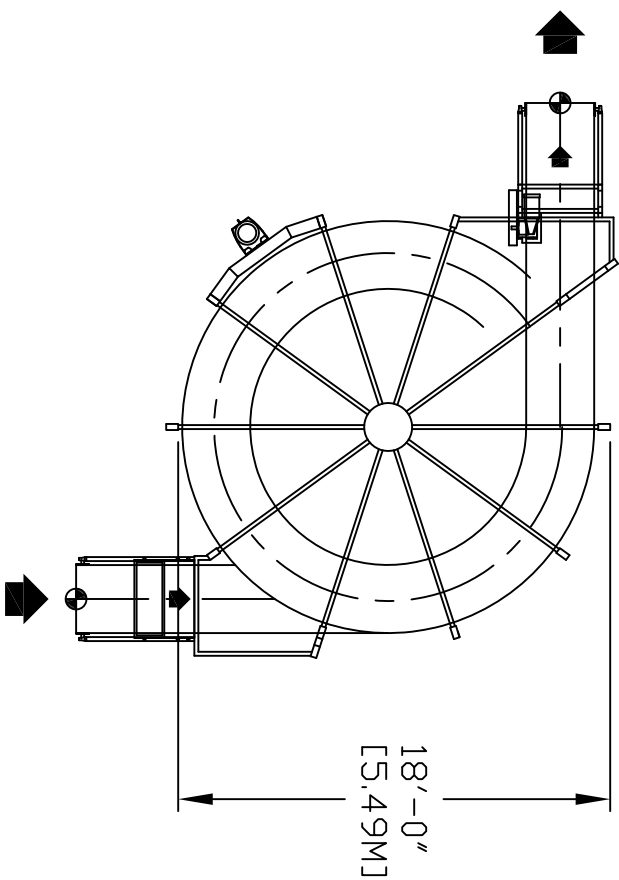

CONFIDENTIAL

THIS DRAWING AND THE MATERIAL CONTAINED THEREIN ARE THE PROPERTY OF I.J. WHITE CORP. AND SHALL NOT BE REPRODUCED, COPIED, OR DISPOSED OF DIRECTLY OR INDIRECTLY, AND SHALL NOT BE USED IN WHOLE OR IN PART, IN THE MAKING OF OR FOR THE PURPOSE OF FURNISHING ANY INFORMATION FOR THE MAKING OF DRAWINGS, PRINTS, APPARATUS, OR PARTS THEREOF, OR FOR ANY OTHER PURPOSE WHATSOEVER, WITHOUT THE PRIOR WRITTEN CONSENT OF THE I.J. WHITE CORP. ALL MATERIAL CONTAINED HEREIN ORIGINATING WITH THE I.J. WHITE CORP. SHALL REMAIN THE PROPERTY OF THE I.J. WHITE CORP.

SINCE 1919

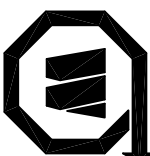

I.J. WHITE SYSTEMS

SCALE	1/8"=1'	DRAWN BY	EJW
SHEET SIZE	A	APPROVED BY	
TITLE	I.J. WHITE SYSTEMS		
DATE	10/22/12	DRAWING NUMBER	IJW-04516

JOB NUMBER	
DATE	
ACCEPTED BY	

10'-9" [3.28M]
OVERALL
SYSTEM
ELEVATION

9'-8 3/8" [2.96M]
DISCHARGE
ELEVATION

2'-2 3/8" [0.67M]
INFEEED
ELEVATION